

OPERATION MANUAL

SD CARD LOGGER/MONITOR



- | | |
|-------------------------------------|------------------------------|
| ■ 87797 WBGT SD Card Logger | ■ 87796 WBGT Monitor |
| ■ 87798 Dew Point SD Card Logger | ■ 87791 Dew Point Monitor |
| ■ 87799 IN/OUT Temp. SD Card Logger | ■ 87792 IN/OUT Temp. Monitor |

INDEX

	PAGE
● INTRODUCTION.....	1
● MATERIAL SUPPLIED.....	1
● POWER SUPPLY.....	2
● LCD DISPLAY.....	3
● HOUSING & KEYPAD.....	4-5
● OPERATION.....	6
-STARTING UP.....	6
-SETUP.....	6
-REAL TIME CLOCK SETTING.....	6
-ALARM SETTING.....	8
-LOGGING SAMPLING RATE.....	11
-TEMPERATURE UNIT SETTING.....	11
-DATALOGGING.....	12
-SD CARD PREPARATION.....	12
-SD CARD LOGGING SETUP.....	13
-SD CARD LOGGING START/STOP.....	14
-SD CARD DATA REVIEW.....	15
-MAXIMUM AND MINIMUM MEASUREMENT...	15
● MAINTENANCE.....	16
● TROUBLE SHOOTING.....	16
● APPENDIX : WGBT & DEW POINT.....	17
● SPECIFICATION.....	19
● RETURN AUTHORIZATION.....	20

INTRODUCTION

Thank you for purchasing the monitor. This meter is user-friendly and reliable. Please read this manual thoroughly before operation.

Features:

- Simultaneously display temperature and humidity
- SD card logging design for continuous recording(87797/98/99 only)
- Easy-to-read super big LCD display
- Check outdoor temp. through external probe (87792/99 only)
- Programable danger zone for warning purpose
- Design with capacitance RH Sensor to get accurate & quick reading
- Temperature unit °C/°F switchable
- Max/Min function to review data
- Battery low indicator
- Real time display (hour & Minute, AM/PM)
- Desktop & wall-mounted design for long time monitor
- Audible beeper & red LED for danger zone warning
- Long Battery Life (via Alkaline Battery)
 - No Logging status: One Year
 - SD Card Logging: One Month (sampling Rate:1min, 1G SD card)

MATERIAL SUPPLIED

	87797/87798	87799	87796/87791	87792
Meter	✓	✓	✓	✓
Adaptor	✓	✓	N/A	N/A
Battery	Optional	Optional	✓	✓
Probe(Built in)	N/A	✓	N/A	✓
SD card	✓	✓	N/A	N/A
Plain box	✓	✓	✓	✓
Manual	✓	✓	✓	✓

POWER SUPPLY

Adaptor

For SD card logger series, it can be powered by 5VDC adaptor and 3pcs AAA batteries.

One 5V adaptor (I/P: AC 100-240V, 50/60Hz, O/P: DC5V, 0.5A) encloses in each SD card logger package. Suggest to use adaptor for long-term logging. 4 different plugs are packed with each adaptor , choose and assemble the correct plug per your need.

The power jack is on the right side of the meter.

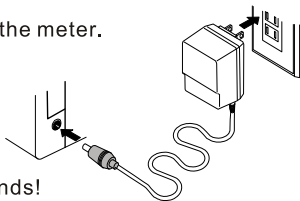

Caution:

1. Don't operate adaptor with wet hands!
2. In a black-out, the meter will be shut-off. When electric power is reverted, the meter will not be activated automatically. Suggest to use battery as spare power even the adaptor is plugged.
3. While using adaptor and battery at the same time, low battery icon will not appear even the battery power is low. Suggest to renew the spare battery regularly.

Battery

SD card logger series and regular monitor series are both able to be powered by 3pcs AA batteries.

While in logging status, the battery life time under below condition is 1 month:

25°C operation temp., 1 min sampling rate, no warming setting, 1G SD card, alkaline battery.

While in regular monitor status, the battery life time is 1 year via using 3pcs alkaline batteries.

When low battery icon appears on LCD, please remove the battery cover from the rear side and install 3 new AA batteries into the battery compartment with correct polarity and good contact.

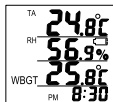



Caution:

1. High capacity SD card and high operating temp. will shorten the battery life.
2. Please finish the battery replacement process in one minute otherwise the meter setting will be reverted to default.
3. Please remove the batteries before long term storage.
4. Don't mix use the new and old battery to avoid battery leakage.
5. Please follow up your local rules to handle the exhausted battery

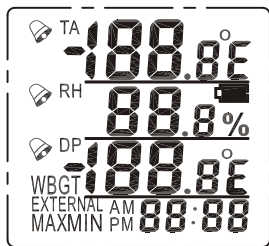
LCD DISPLAY



1. Top data screen displays air temp.
2. Middle data screen displays humidity
3. Lower data screen displays WBGT (87796/97) or Dew point (87791, 98) or external probe temp. (87792, 99)
4. The " MIN " & " MAX " icon indicates the minimum & maximum value since power on.
5. The "  " indicates the reading is over the warming threshold
6. "  " is battery full indicator, "  " is battery low indicator
7. Bottom display is real time display (24HR or AM/PM) and SD card status display:
 - SD**: displayed every 5 seconds to indicate the SD card is inserted
 - REC**: displayed every 5 seconds to indicate the logging is activated
 - FULL**: displayed every 5 seconds to indicate the SD card capacity is full
 - SD&Err**: displayed in turns to indicate the SD card is useless on this meter

HOUSING & KEYPAD

FRONT

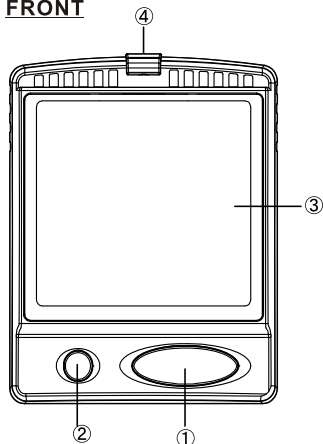

1. **Power** key to turn on /off the meter
2. **SET** key to program parameters:
 - high/ low alarm setting
 - sampling rate (logger series only)
 - start/stop logging
 - ON/OFF beeper
3. Large LCD with air temp./humidity /WBGW or DP or EXTERNAL/time display
4. Bright red LED alarm

REAR

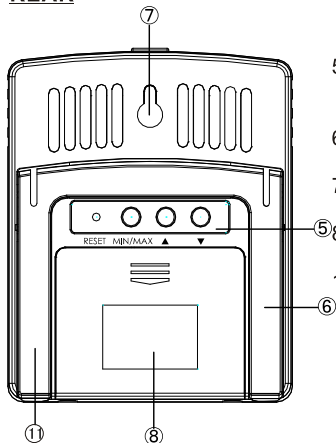

5. Rear side operation key (see next page)
6. Desktop mount
7. Wall-mounted hole
8. Battery compartment
11. External cable (87792, 87799 only)

RIGHT SIDE

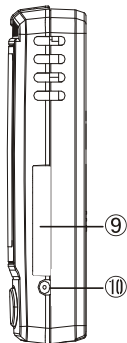

9. SD card slot

- Press “●●●” to raise the slot cover.
- Insert the SD card by following the icon reminder on housing.
- To take out the SD card, press the SD card to eject.

10. Adaptor socket.

NOTE:

For regular monitor series, this side is flat without SD slot & adaptor socket

REAR OPERATION KEY

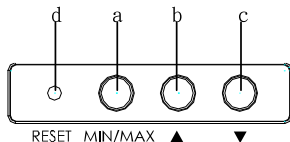

- a. Press to check the MIN or MAX value of temp. & humidity since power on.
Press more than 2 sec. to reset the MIN/MAX memory

- b. Press to increase the value while setting
Press to switch temperature unit °C or °F

- c. Press to decrease the value while setting

Press with “**SET**” key simultaneously for 2 seconds to enter the real time clock setting.

- d. When the meter is crashed, use small tip to reset the meter and revert to default setting.

OPERATION

STARTING UP

1. Connect with adaptor and install 3 pcs AA batteries as spare power source. (See page 2)
2. Press “ ON/OFF” key to power on the meter. If the measured value is over the limit, the beeper sounds and red LED flashes for first 10 seconds and then beeper sound will be off.
3. Program the real time and alarm setting for the first time using. Without the batteries as spare power source, all the parameters will be defaulted after the adaptor power is removed.

SETUP

The advanced **SETUP** function lets you customize your meter's preferences and defaults. The programmable parameters are:

1. Real time setting:

24 hour/12 hour, hour, minute and date (SD logger series only)

2. Alarm setting:

High and low threshold setting for air temp., air humidity, WBGT or dew point or external temp. probe.

3. Sampling rate: (SD logger series only)

Logging sampling rate setting from 1 min to 720 mins.

4. Temp. unit setting:

Degree C or Degree F setting.

REAL TIME CLOCK

Use this program to adjust local time of the meter. With the adaptor connected or batteries installed, the power will drive the real time clock even the meter is turned off.

1. When meter is on, press “**SET**” key and “▼” key simultaneously for 2 seconds to enter the real time clock setting.
2. Press “▼” or “▲” key to program the time format as 12 Hours or 24 Hours

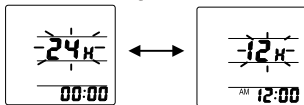

3. Press “ **SET** ” key to confirm the time format and enter Year setting. Press “ **▲** ” or “ **▼** ” key to program the year.(For 87797/98/99 only)
For example:
2010 is displayed as 10 .
2011 is displayed as 11 . .



4. Press “ **SET** ” key to confirm the Year setting and enter Month setting. Press “ **▲** ” or “ **▼** ” key to program the Month.(For 87797/98/99 only)



5. Press “ **SET** ” key to confirm the Month setting and enter Day setting. Press “ **▲** ” or “ **▼** ” key to program the Day.(For 87797/98/99 only)



6. Press “ **SET** ” key to confirm the Day setting and enter Hour setting. Press “ **▲** ” or “ **▼** ” key to program the Hour.



6. Press “ **SET** ” key to confirm the Hour setting and enter Minute setting. Press “ **▲** ” or “ **▼** ” key to program the Minute.



7. Press “ **SET** ” key to confirm the Minute setting and revert to normal display

NOTE:

- 1. YEAR/MONTH/DAY setting are not available in 87791/87792/ 87796 three models.**
- 2. Before starting the datalogging, be sure to program the meter with correct date and time. To change the date and time while logging will stop the logger right away.**

ALARM SETTING

Use this function to set the high & low threshold of each parameters

Alarm is activated while measurement is over the threshold:

1. Symbol warning

When the measured value is higher than the high limit threshold or lower than the low limit threshold, the “” symbol flashes on LCD at the left side of measured value.

The symbol disappears when the measured value is reverted to normal range.



2. LED flash warning

When the measured value is higher than the high limit threshold or lower than the low limit threshold, the red LED flashes for about 10 seconds. After the initial 10 seconds, the LED flashes every 10 second until the measured value is back to normal range.

3. Beeper alarm warning

When the measured value is higher than the high limit threshold or lower than the low limit threshold, the beeper sounds for about 10 seconds. After the initial 10 seconds, the beeper sounds every 10 second until the measured value is back to normal range.

Beeper alarm ON/OFF

To mute the alarm beeper, short press “**SET**” key once and “**OFF**” will appear on LCD. Symbol flash and LED flash will not be affected by this program.



To activate the alarm beeper sound, short press “**SET**” key again and “**ON**” will appear on LCD.



Alarm Setup

1. When meter is on, press “**SET**” key for 3 seconds and release key while seeing “**SET**” appear on the bottom of the LCD. After releasing key, the LCD is in alarm setting mode and ready for programming.



2. Press “**SET**” key repeatedly to select the parameters which you want to program. The programmable values are:
TA Low limit --> TA High limit --> RH% Low limit --> RH% High limit
-->WBGT or DP or EXT. Low limit -->WBGT or DP or EXT. high limit -->**Datalogging (87797/98/99 only)** --> Ending

3. TA Low alarm limit setup (adjustable range:-10.0~70.0°C):

- Press “▲” or “▼” key to adjust the TA low limit threshold.
- While need to leave the setting blank, press “**MIN/MAX**” key to erase the previous setting and LCD displays “---”.
- Press “**SET**” key to confirm the setting and enter TA high alarm limit setup.



4. TA High alarm limit setup (adjustable range:-10.0~70.0°C):

- Press “▲” or “▼” key to adjust the TA high limit threshold.
- While need to leave the setting blank, press “**MIN/MAX**” key to erase the previous setting and LCD displays “---”.
- Press “**SET**” key to confirm the setting and enter RH% low alarm limit setup.

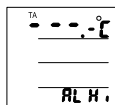

5. RH% Low alarm limit setup (adjustable range:5%~95%):

- Press “▲” or “▼” key to adjust the RH% low limit threshold.

- While need to leave the setting blank, press "**MIN/MAX**" key to erase the previous setting and LCD displays " - - - " .
- Press "**SET**" key to confirm the setting and enter RH% high alarm limit setup.

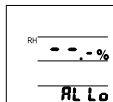

6. TA High alarm limit setup (adjustable range:5%~95%):

- Press "**▲**" or "**▼**" key to adjust the RH% high limit threshold.
- While need to leave the setting blank, press "**MIN/MAX**" key to erase the previous setting and LCD displays " - - - " .
- Press "**SET**" key to confirm the setting and enter WBGT (87796/97) or DP(87791/98) or EXT(87792/99)low alarm limit setup.

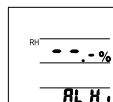

7. **WBGT** Low alarm limit setup (model:87796/87797 only)

Adjustable range:0.0~60.0°C

DP Low alarm limit setup (model 87791/87798 only)

Adjustable range:-20.0~70.0°C

EXT Low alarm limit setup (model 87792/87799 only)

Adjustable range:-30.0~70.0°C

- Press "**▲**" or "**▼**" key to adjust the low limit threshold.
- While need to leave the setting blank, press "**MIN/MAX**" key to erase the previous setting and LCD displays " - - - " .
- Press "**SET**" key to confirm the setting and enter high alarm limit setup.

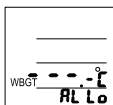

8. **WBGT** High alarm limit setup (model:87796/87797 only)

Adjustable range:0.0~60.0°C

DP High alarm limit setup (model 87791/87798 only)

Adjustable range:-20.0~70.0°C

EXT High alarm limit setup (model 87792/87799 only)

Adjustable range:-30.0~70.0°C

- Press “▲” or “▼” key to adjust the high limit threshold.
- While need to leave the setting blank, press “MIN/MAX” key to erase the previous setting and LCD displays “- - -”.
- Press “SET” key to confirm the setting and finish the high alarm limit setup.

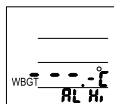

LOGGING SAMPLING RATE (MODEL 87797/98/99 ONLY)

Use this function to setup the logger sampling rate. The setting range is 1~720 minutes. The default is 10 mins.

1. When meter is on, press “SET” key for 3 seconds and release key while seeing “SET” appear on the bottom of the LCD. After releasing key, the LCD is in alarm setting mode and ready for programming.
2. Press “SET” key repeatedly to skip the alarm setting and entering logger sampling rate setup.
3. Press “▲” or “▼” key to adjust the sampling rate.
4. Press “SET” key to confirm the setting and revert to normal display.

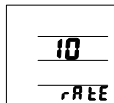

TEMPERATURE UNIT SETTING

Use this function to setup the temperature unit of your meter.

1. When meter is on, press “▲” key >2 seconds until you see the temperature unit change. Press “▲” again to change it.
2. Automatically saving after 10 seconds “▲” key inactivity.

DATALOGGING- MODEL 87797/98/99 ONLY

The advanced SD card logging function lets you record all data into SD card per your preset sampling rate. The sampling rate can be 1 mins to 720 mins(12 hours).

Once a new logging is started, a file name will be auto created. The file name is given per the start date and time. For example: if the logging starts at 2010/08/28 16:58, the file name will be given as 08281658.txt

The maximum file size is 30000 records. Once the file size is bigger than 30000 records, a new file will be created and the file name will be generated.

NOTE:

A complete date/time/TA/RH%/TEMP. data is treated as 1 record.

SD CARD PREPARATION

This product is compatible with FAT16 & FAT32 format SD card. Suggest maximum SD card capacity is 8GB SD or 4GB SDHC card.

Before loading or unloading the SD card into meter, please following below suggestion:

1. The data loss caused by the damaged SD card is not in product warranty. Please make sure your SD card can function well before running a logging.
2. This product is compatible with FAT16 & FAT32. No NTFS format.
3. Check the available SD card capacity before logging. This meter will show "FULL" if the capacity is not enough for logging.
4. This meter is designed to use SD or SDHC cards only.
5. This instrument has not been extensively tested by MMX and SDHC which capacity is over 8GB, so we do not recommend using.

6. We don't warranty that all brands SD card are compatible with this meter. Suggest to run a short-term logging to ensure your SD card is working on this logger before official recording.
7. Please don't add extra label on SD card in case the label is stuck on the SD card slot.
8. Following the correct direction to load the SD card. **Always power off the meter before loading and unloading the SD card.**
9. Avoid to use the SD card in strong statics, high temperature or high humidity environment to minimize the SD card damage.

SD CARD LOGGING SETUP

Always power off the meter before loading and unloading the SD card. Run a short-term logging to ensure the SD card works well on meter.

Following below steps to start a logging.

1. Power off the meter and load the SD card. Power on the meter, "Sd" flashes on the right-bottom of the LCD every 5 seconds.
2. Setup the date and time. Please see page 6
3. Setup the sampling rate. Please see page 11
4. The datalogging can be powered by battery however the battery life time is short. For example: While sample rate is 1 min and using 1GB SD card, the battery life time is 1 month only. Suggest to use adaptor for long-term logging. While in a black-out, the logging will stop and will not be reverted even the electric is back.
5. If possible, using both battery and adaptor. While in a black-out, the logging can be continued by using battery.

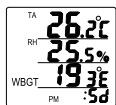

NOTE:

1. When receiving the meter, one SD card is inserted in meter already for initial functional testing.

SD CARD LOGGING START/ STOP

After finishing the sampling rate setting, press “**SET**” key more than 5 seconds to activate the logging. “**ON REC**” will appear on LCD and start to record data into SD card.

1. The “**ON REC**” will appear on LCD for 2~10 seconds, depended on the SD card capacity.
2. While starting logging, “**REC**” appears on LCD every 5 seconds.
3. Power off the meter will terminate the logging. Power on the meter again will not activate the logging again.
4. While logging, unload the SD card will stop the logging. “**sd**” & “**Err**” appear on the LCD interchangeably.

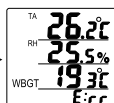
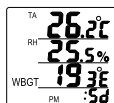
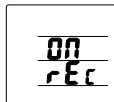

NOTE:

Following conditions will terminate the logging. Repeat above steps again to re-activate the logging.

1. Power off the meter
 2. While low battery icon appears on LCD
 3. In a black-out while using adaptor only
 4. SD card unload
 5. Real time clock setting change
 6. Sampling rate setting change
 7. Alarm threshold setting change
 8. Temperature unit change
 9. Press “**RESET**” to stop the logging
5. Press “**SET**” key more than 5 seconds to stop the logging. “**OFF rEc**” appears on LCD and SD logging stops.
 6. To unload the SD card, power off the meter first. Press the SD slot door and push SD card to eject.

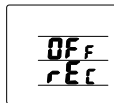

SD CARD DATA REVIEW

The recorded data is stored in SD card in following format:

Temperature unit is depended on setting

DATE	TIME	Tair(C)	RH(%)	WBGT(C)
2010-03-18	16:10:00	025.0	26.2	018.2
2010-03-18	16:11:00	025.0	26.7	018.3
2010-03-18	16:12:00	024.9	26.5	018.3
2010-03-18	16:13:00	024.9	26.2	018.2
2010-03-18	16:14:00	024.8	26.0	018.2
2010-03-18	16:15:00	024.8	25.7	018.1
2010-03-18	16:16:00	024.7	25.4	018.1

Example: 87797

Please use external SD card reader if you don't have this device built in your computer. The SD card reader is not included in our standard package. Please purchase it from your local stores.

MAXIMUM AND MINIMUM MEASUREMENT

This meter can show you the maximum and minimum value since power on.

1. Press "**MIN/MAX**" key once, "MIN" appears on LCD left bottom. The minimum TA, RH% and WBGT(or DP, or EXT) appear on LCD.

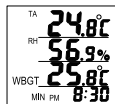

2. Press "**MIN/MAX**" key again, "MAX" appears on LCD left bottom. The maximum TA, RH% and WBGT(or DP, or EXT) appear on LCD.

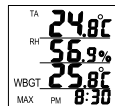

3. To clear the maximum and minimum value, press "**MIN/MAX**" key more than 2 seconds until the whole LCD flash once.

MAINTENANCE

To clean the housing of the meter, please use dry, clean and soft cloth. Don't use any chemical solution or polishing powder to clean the plastic.

TROUBLESHOOTING

? METER COULD NOT BE POWERED ON

- Press "POWER" key > 0.3sec.
- Check the connection status of adaptor or batteries.

? SLOW RESPONSE

- The meter is designed to update the value every 10 seconds. It is normal to see an unchanging reading for the initial few seconds while the measured environment is dramatically changed.

? ERROR CODES STAND FOR:

<u>Error</u>	<u>Problem & Solution</u>
E02	The value is under the lower limit. <u>Solution</u> : Operate the meter in specified range only.
E03	The value is over the upper limit . <u>Solution</u> : Operate the meter in specified range only.
E04	The temperature sensor or circuit error. <u>Solution</u> : Relief E02/03 first. If not working, sent back for further investigation.
E11	Humidity sensor or circuit error. <u>Solution</u> : sent back for further investigation.
E32	IC failure.
E33	IC failure. <u>Solution</u> : sent back for further investigation.

APPENDIX : WBGT AND DEW POINT

APPENDIX A: WHAT IS WBGT

The Wet Bulb Globe Temp. (WBGT) is a composite temperature used to estimate the effect of temperature, humidity, wind speed and solar radiation on humans. It is used by industrial hygienists, athletes, and the military to determine appropriate exposure levels to high temperatures.

Recommendations to heat exposure level for working and physical activity!

PERMISSIBLE HEAT EXPOSURE THRESHOLD LIMIT

Work/rest regimen (Each hour)	Light	Moderate	Heavy	Value:WBGT
Continuous work	30°C /86°F	26.7°C /80°F	25°C /77°F	
75% work, 25% rest	30.6°C /87°F	28°C /82°F	25.9°C /78°F	
50% work, 50% rest	31.4°C /89°F	29.4°C /85°F	27.9°C /82°F	
25% work, 75% rest	32.2°C /90°F	31.1°C /88°F	30°C /86°F	

Source: ACGIH 1992(*The American Conference of Governmental Industrial Hygienists*)

WBGT INDEX AND PHYSICAL EXERCISE

WBGT	Flag	Activity Intensity
< 80°F < 26.7°C	White	Normal activity. Caution should be taken.
80-84.9°F 26.7-29.4°C	Green	Discretion is required in planning intense physical activity.
85-87.9°F 29.4-31°C	Yellow	Intense activity for new and unacclimatized persons should be curtailed.
88-89.9°F 31-32.2°C	Red	Intense exercise must be curtailed for those with less than 12 weeks training in hot weather. Be on high alert.
> 90°F > 32.2°C	Black	Cancel all outdoor exercise.

Source: Manual of Naval Preventive Medicine (NAVMED P-5010)

APPENDIX B: WHAT IS DEW POINT

The dew point temperature is the temperature at which the air can no longer hold all of its water vapor and some of the water vapor must condense into liquid water. Condensation of water vapour begins when the temperature of air is lowered to its dew point and beyond.

Dew Point Application:

- In summer or high humidity season, identifies and warns when conditions for mold growth exist.
- In winter or low humidity season, identifies and warns when conditions for static electricity exist.
- Air temperature and dew point temp. indicate where condensation may occur
- Monitor conditions in laboratories, basement and other controlled environment settings

SPECIFICATION

MODEL	SD card	TA	RH%	WBGT	DP	EXTERNAL(EXT)
87796		●	●	●		
87797	●	●	●	●		
87791		●	●		●	
87798	●	●	●		●	
87792		●	●			●
87799	●	●	●			●

87792/99

87791/87798

87796/87797

Temp. range	0~50°C (Display: -10.0~70.0°C)					
Temp. resolution	0.1°C/°F					
Temp. accuracy	+/-1°C					
Humidity. range	20~90%RH (Display:0%~99.9%RH)					
Humidity resolution	0.1%RH					
Humidity accuracy	+/-5%RH (at 25°C, 10~90%RH, others +/-7%RH)					
WBGT range	0~60.0°C					
DP range	-20~70°C					
External temp. Range	-10~70°C (Display: -30~70°C)					
External temp. resolution	0.1°C/°F					
External temp. accuracy	+/-0.6°C (0~50°C) +/-1.2°C(-10~0°C, 50~70°C) No specified for -30°C~-10°C					
External probe size	Dia.4mm x Length:25mm					
External probe cable	2M long, material: PVC					
External probe IP level	IP65					
SD card	Max. 8GB SD or SDHC card					
Sampling rate	1 to 720 mins for SD logger series					
Beeper (dB)	~65dB					
LCD size (mm)	63(H)x70(W)					
Operation temp.	0~50°C					
Operation RH%	Humidity < 90%					
Storage temp.	-10~50°C					
Storage RH%	Humidity < 90%					
Dimension(mm)	110x91x30(H)					
Weight	~200g					
Power	AA x3pcs or 5V adaptor					
Standard Package	Meter/adaptor or battery /Manual/Paper box/SD card (SD logger series)					

WARRANTY

The meter is warranted to be free from defects in material and workmanship for a period of one years from the date of purchase. This warranty covers normal operation and does not cover battery, misuse, abuse, alteration, tampering, neglect, improper maintenance or damage resulting from leaking batteries.

Proof of purchase is required for warranty repairs. Warranty is void if the meter has been opened .

RETURN AUTHORIZATION

Authorization must be obtained from the supplier before returning items for any reason. When requiring a RA (Return Authorization), please include data regarding the defective reason, the meters are returned along with good packing to prevent any damage in shipment and insured against possible damage or loss.

PATENT

TAIWAN PATENT #

JAPAN PATENT #

**Accuracy, the Zenith of
Measuring / Testing Instruments !**

Hygrometer/Psychrometer

Thermometer

Anemometer

Sound Level Meter

Air Flow meter

Infrared Thermometer

K type Thermometer

K.J.T. type Thermometer

K.J.T.R.S.E. type Thermometer

pH Meter

Conductivity Meter

T.D.S. Meter

D.O. Meter

Saccharimeter

Manometer

Tacho Meter

Data logger

Temp./RH transmitter

Wireless Transmitter

More products available !

2016.06.V03